

Total solder points: 150

Difficulty level: *beginner* 1 2 3 4 5 *advanced*

Intelligent lead acid battery charger

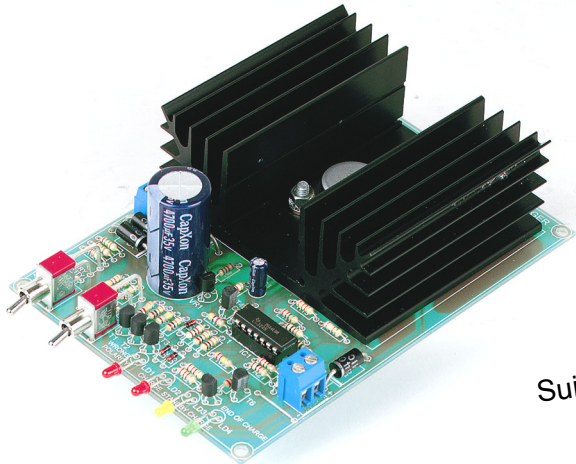

K8012

Suitable for 6V and 12V sealed and open lead-acid batteries

Features:

- ☑ Suitable for 6V and 12V sealed and open lead-acid batteries.
- ☑ Fully automatic charge and maintenance cycle.
- ☑ Status indicators for charge, float and end-of-charge
- ☑ Protected against polarity reversal

Specifications:

- Power Supply: 2 x 9V/25VA
- Charge current : 0,3 or 1A selectable
- Dimensions (wxdxh): 97 x 140 x 41mm / 3,8 x 5,5 x 1,6"



Not suitable for non-rechargeable or NiCd/NiMH batteries !

Options:

- Transformer prim. 230V - sec. 2x9V/25VA: 2090250MST
- Enclosure: TKAUS22G
- Power cord: NETSNOER

1. Assembly (Skipping this can lead to troubles !)

Ok, so we have your attention. These hints will help you to make this project successful. Read them carefully.

1.1 Make sure you have the right tools:

- A good quality soldering iron (25-40W) with a small tip.
- Wipe it often on a wet sponge or cloth, to keep it clean; then apply solder to the tip, to give it a wet look. This is called 'thinning' and will protect the tip, and enables you to make good connections. When solder rolls off the tip, it needs cleaning.
- Thin raisin-core solder. Do not use any flux or grease.
- A diagonal cutter to trim excess wires. To avoid injury when cutting excess leads, hold the lead so they cannot fly towards the eyes.
- Needle nose pliers, for bending leads, or to hold components in place.
- Small blade and Phillips screwdrivers. A basic range is fine.

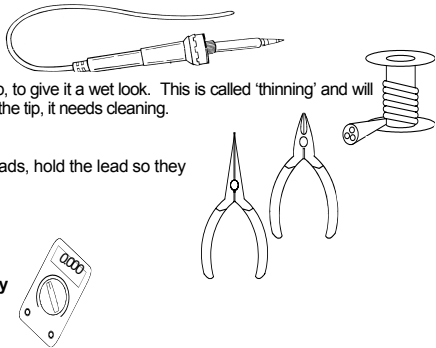

For some projects, a basic multi-meter is required, or might be handy

1.2 Assembly Hints :

- ⇒ Make sure the skill level matches your experience, to avoid disappointments.
 - ⇒ Follow the instructions carefully. Read and understand the entire step before you perform each operation.
 - ⇒ Perform the assembly in the correct order as stated in this manual
 - ⇒ Position all parts on the PCB (Printed Circuit Board) as shown on the drawings.
 - ⇒ Values on the circuit diagram are subject to changes.
 - ⇒ Values in this assembly guide are correct*
 - ⇒ Use the check-boxes to mark your progress.
 - ⇒ Please read the included information on safety and customer service
- * Typographical inaccuracies excluded. Always look for possible last minute manual updates, indicated as 'NOTE' on a separate leaflet.

1.3 Soldering Hints :

1- Mount the component against the PCB surface and carefully solder the leads

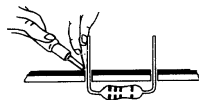

2- Make sure the solder joints are cone-shaped and shiny

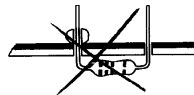
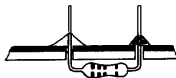

3- Trim excess leads as close as possible to the solder joint

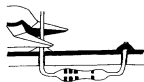

REMOVE THEM FROM THE TAPE ONE AT A TIME !

AXIAL COMPONENTS ARE TAPED IN THE CORRECT MOUNTING SEQUENCE !

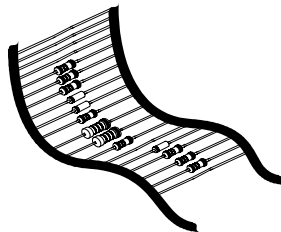

1. Jumper wires

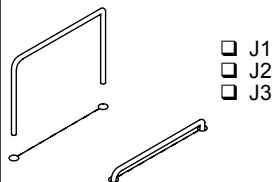

2. Diodes (150mA). Watch the polarity !

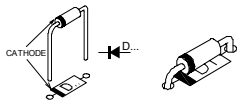

- D1 : 1N4148
- D2 : 1N4148
- D3 : 1N4148

3. Metal film resistors (1%)

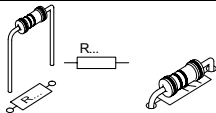

- R1 : 47K (4-7-0-2-1)
- R2 : 27K (2-7-0-2-1)
- R3 : 120K (1-2-0-3-1)
- R4 : 180K (1-8-0-3-1)
- R6 : 270K (2-7-0-3-1)

4. 1/4W resistors

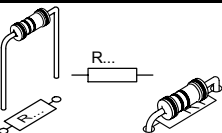

- R5 : 10K (1-0-3-B)
- R7 : 10K (1-0-3-B)
- R8 : 1K5 (1-5-2-B)
- R9 : 1K (1-0-2-B)
- R10 : 10K (1-0-3-B)
- R11 : 4K7 (4-7-2-B)
- R12 : 1K (1-0-2-B)

- R13 : 10K (1-0-3-B)
- R14 : 10K (1-0-3-B)
- R15 : 33K (3-3-3-B)
- R16 : 10K (1-0-3-B)
- R17 : 1M (1-0-5-B)
- R18 : 680 (6-8-1-B)
- R19 : 15K (1-5-3-B)
- R20 : 10K (1-0-3-B)
- R21 : 10K (1-0-3-B)
- R22 : 220K (2-2-4-B)
- R23 : 2K2 (2-2-2-B)
- R24 : 2K2 (2-2-2-B)
- R25 : 12K (1-2-3-B)
- R26 : 1M (1-0-5-B)
- R27 : 1K (1-0-2-B)
- R28 : 2K2 (2-2-2-B)

5. Metal film resistors (5%)

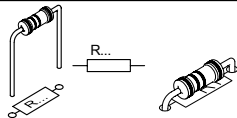

- R29 : 1.5 (1-5-B-B-9)
- R30 : 1.8 (1-8-B-B-9)
- R31 : 2.2 (2-2-B-B-9)

6. IC socket. Watch the position of the notch!

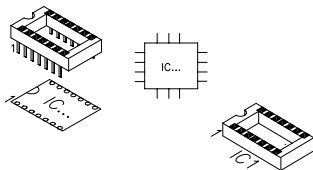

IC1 : 14P

7. Diodes (3A). Watch the polarity!

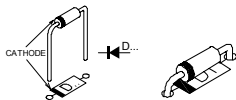

- D4 : 1N5400 ... 1N5408
- D5 : 1N5400 ... 1N5408
- D6 : 1N5400 ... 1N5408
- D7 : 1N5400 ... 1N5408
- D8 : 1N5400 ... 1N5408

8. Transistors

- T1 : BC547
- T2 : BC547
- T3 : BC547
- T4 : BC547
- T5 : BC547
- T6 : BC557

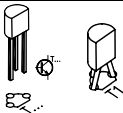

9. Reference diode

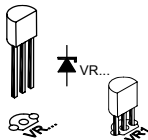

VR1 : LM385Z-2.5

10. Screw connectors

- SK1 : 2p (AC)
- SK2 : 2p (Accu)

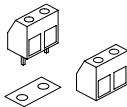

11. Electrolytic capacitor. Watch the polarity!

C1 : 2 μ 2

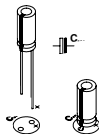

12. Switches

- SW1 : ON - ON
- SW2 : ON - ON

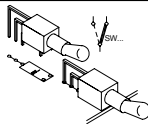

13. Electrolytic capacitor. Watch the polarity!

C2 : 4700 μ F/35V

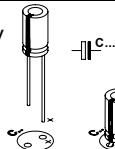

14. Power transistor

□ T1 : MJ3001 or 2N6284G

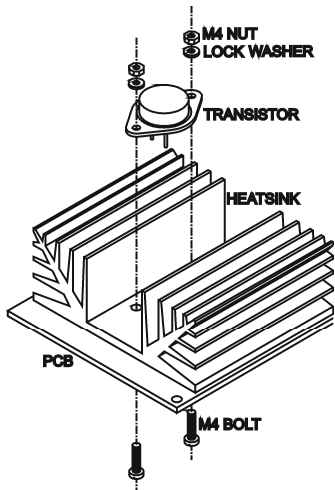

15. LEDs. Watch the polarity!

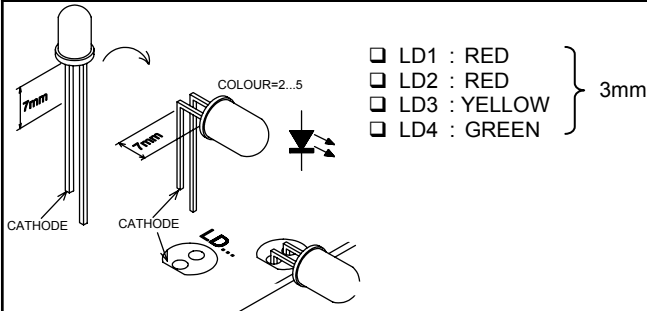

16. IC. Check the position of the notch !

□ IC1: LM324 or eq.

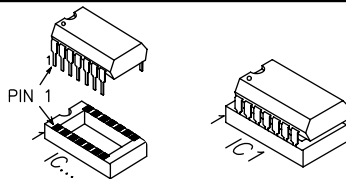

17. Testing

Perform all tests as shown below, before the first use of the unit. It allows you to check every function of your charger kit. Use the supplied 5W dummy load resistors and a reliable multimeter.

- 1- Put SW2 in the 12V position. Measure the voltage across the output terminals. Output voltage should be 13.6V +/- 0.2V.

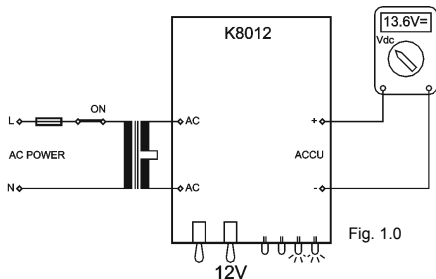

- 2- Put SW2 in the 6V position. Measure the voltage across the output terminals. Output voltage should be 6.8V +/- 0.2V

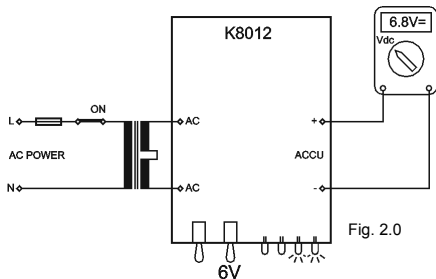

- 3- Put SW2 in the 12V position, put SW1 in the >4Ah position. Connect the supplied $33\Omega/5\Omega$ resistor to the output terminals. Measure the voltage across the resistor. It should read $14.7V \pm 0.1V$

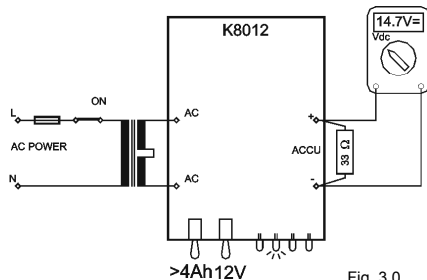

Fig. 3.0

- 4- Put SW2 in the 6V position, put SW1 in the >4Ah position. Connect the supplied $33\Omega/5\Omega$ resistor to the output terminals. Measure the voltage across the resistor. It should read $7.3V \pm 0.1V$

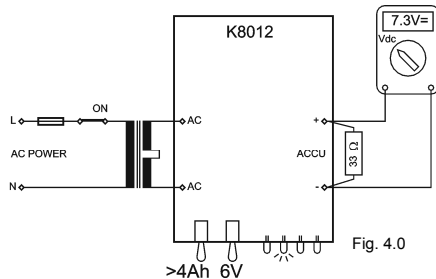
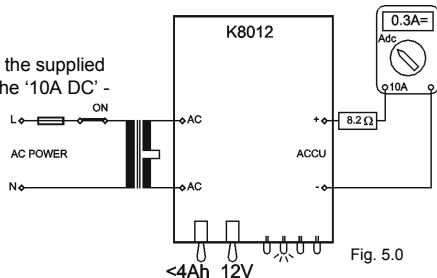
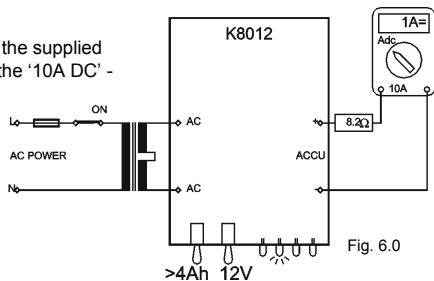

Fig. 4.0

- 5- Put SW2 in the 12V position, put SW1 in the >4Ah position. Connect the supplied 8.2Ω resistor in series with the multimeter. Switch the multimeter to the '10A DC' - position. It should read 1A +/- 0.1A.



- 6- Put SW2 in the 12V position, put SW1 in the <4Ah position. Connect the supplied 8.2Ω resistor in series with the multi-meter. Switch the multimeter to the '10A DC' - position. It should read 0.3A +/- 0.03A.



If any of the measurements show a considerable difference with the reference values, please recheck the entire assembly, and pay special attention to resistor values.

18. Building into an optional enclosure

Figure 7 & 8 provides a drill pattern for our **optional** enclosure (ref. **TKAUS22G**).

The included adhesive front panel label can be used to mark the position of the holes to be drilled.

- Position the label on the front panel and fix it temporary with tape.
- Mark the center of the holes with a center punch.
- Remove the label and drill the holes.

☞ Pay attention to the correct diameter. Make sure all holes are free of burrs.

Degrease the front panel before sticking the label onto it. The label edges will need to be trimmed with a sharp cutter.

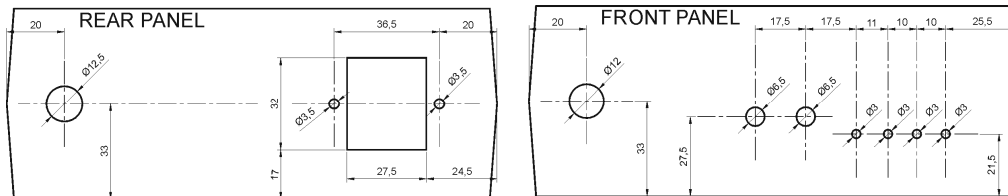

Fig. 7.0

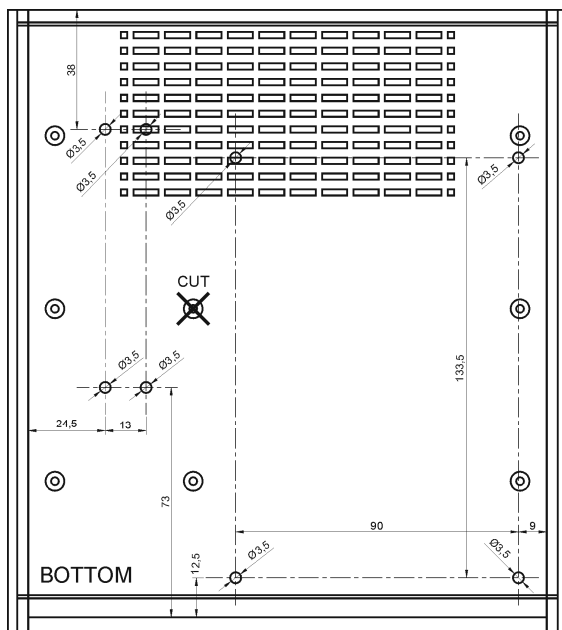
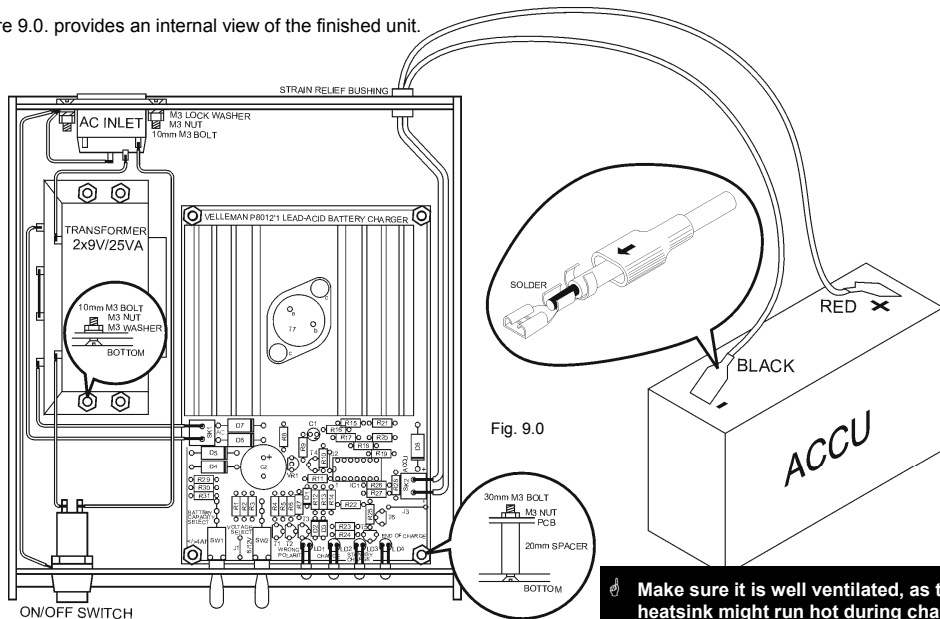

Fig. 8.0

Figure 9.0. provides an internal view of the finished unit.



19. Connection & Use

Connection: The unit can be connected as shown on figure 10.

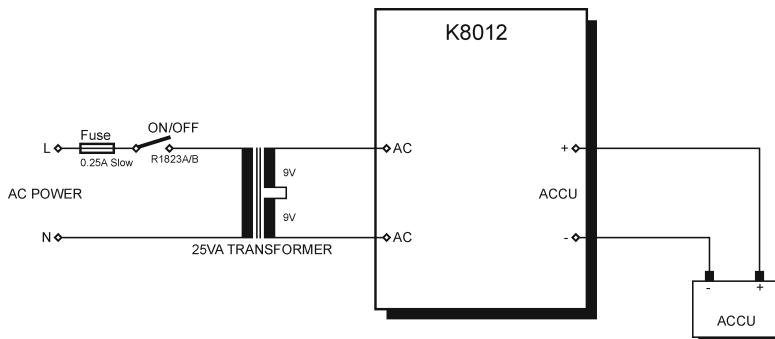

Fig. 10

Make sure your assembly complies with the local safety regulations. For improved safety, use a non-conductive enclosure.

Use: perform the necessary settings before you hook-up the battery to the unit :

- Select the appropriate charge current and voltage according to the capacity of the battery.

Batteries < 4Ah: 0.3A charge current

Batteries > 4Ah: 1A charge current

You can easily estimate the charging time with the following formula :

$$\text{Approx. charging time (hours)} = (\text{battery capacity (Ah)} / \text{charging current (A)}) \times 1.2$$

 **Pay attention to the polarity when you hook-up a battery to the charger.**

- Switch on the unit, to start the charging cycle.

 **Batteries should be charged in a well ventilated area, because of the possible emission of gases.**

20. Operation & troubleshooting

Operation:

When a discharged battery is connected to the unit, it starts charging it with the maximum current (0.3A for batteries <4Ah, 1A for batteries >4Ah), until the battery voltage reaches 14.7V (7.35V for a 6V battery).

Once this voltage is established, the charger adjusts the charge current, in order to keep this voltage steady.

At the end of the charging cycle, when the charge current has dropped significantly, the output voltage is dropped to 13.6V (6.85V for a 6V battery). This allows the battery to remain hooked-up to the charger without any risk for an indefinite time.

Should the battery discharge, then the charge cycle will restart automatically.

Troubleshooting:

If you have successfully completed the above tests, there is not much that can go wrong.

If the unit never leaves the 'charge' cycle, this could point to either a defective battery, a too low charge current setting, or a battery with a too large capacity.

21. PCB

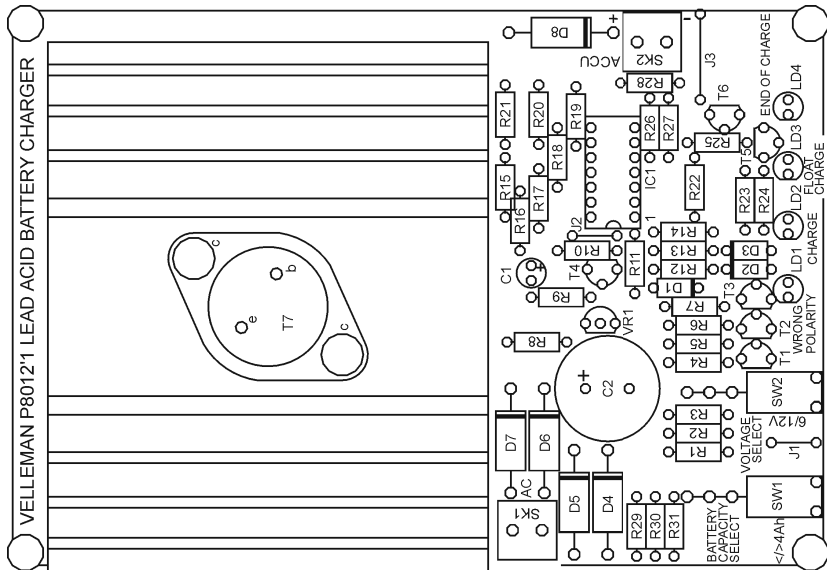

22. Schematic diagram.

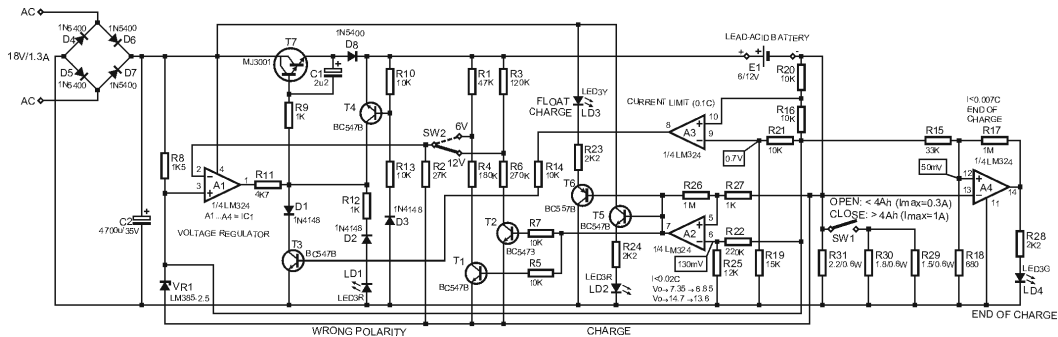



Modifications and typographical errors reserved

© Velleman Components nv.

H8012IP - 2010 - ED1 (rev.1)

